

## TUNING FORK CRYSTAL UNIT (SMD · Ceramic Package)

RoHS compliant / Pb free

# CM315H

3,000pcs/reel

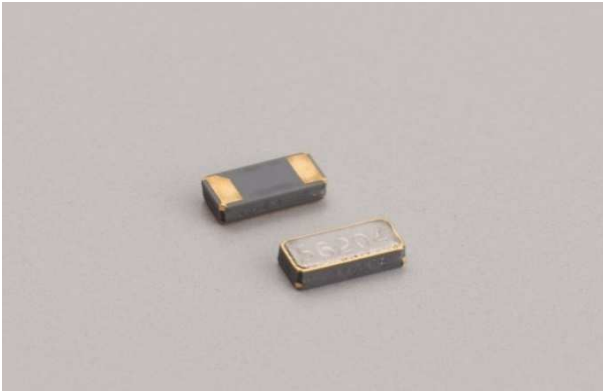

### ■ FEATURES

- Frequency range : 32.768kHz
- External dimensions (mm)  
L : 3.2 x W : 1.5 x H : 0.9
- AEC-Q200 Qualified  
High reliable performance
- Applications  
Automotive (Non-safety applications)  
Industrial / Medical (Non-life dependent)

### ■ DIMENSION [mm]

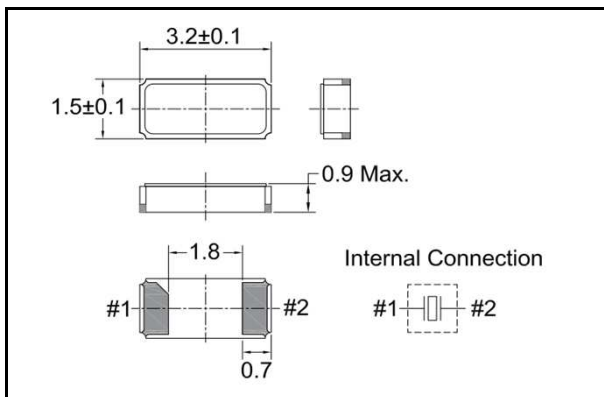

### ■ SOLDER PAD LAYOUT [mm]

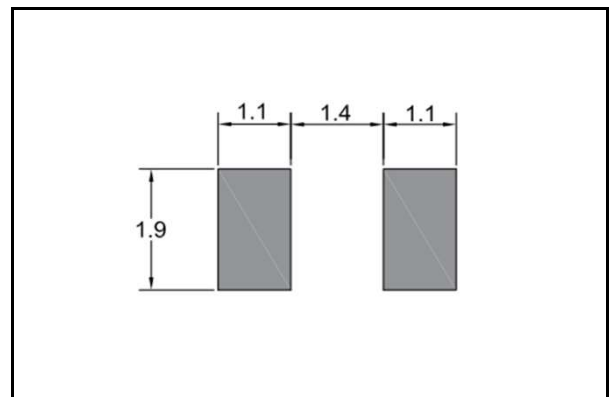

### ■ STANDARD SPECIFICATIONS

Item	Model	CM315H	Conditions
Nominal Frequency	$f_0$	32.768kHz	
Frequency Tolerance	$\Delta f/f_0$	$\pm 20\text{ppm}$	at 25°C
Load capacitance	$C_L$	9.0pF / 12.5pF	Please specify your requirement
Operating Temperature Range	$T_{OPR}$	-40°C ~ +125°C	
Storage Temperature Range	$T_{STR}$	-55°C ~ +125°C	
Turnover Temperature	$T_M$	25°C±5°C	
Temperature Coefficient	$\beta$	$-0.034 \pm 0.006\text{ppm}/^\circ\text{C}^2$	
Motional (series) resistance	$R_1$	90K $\Omega$ Max.	
Level of drive	$D_L$	1 $\mu\text{W}$ Max.	
Aging (first year)	$\Delta f/f_0$	$\pm 3\text{ppm}$ Max.	25°C±3°C
Shunt capacitance	$C_0$	0.95pF Typ.	

## ■ PART NUMBERING SYSTEM

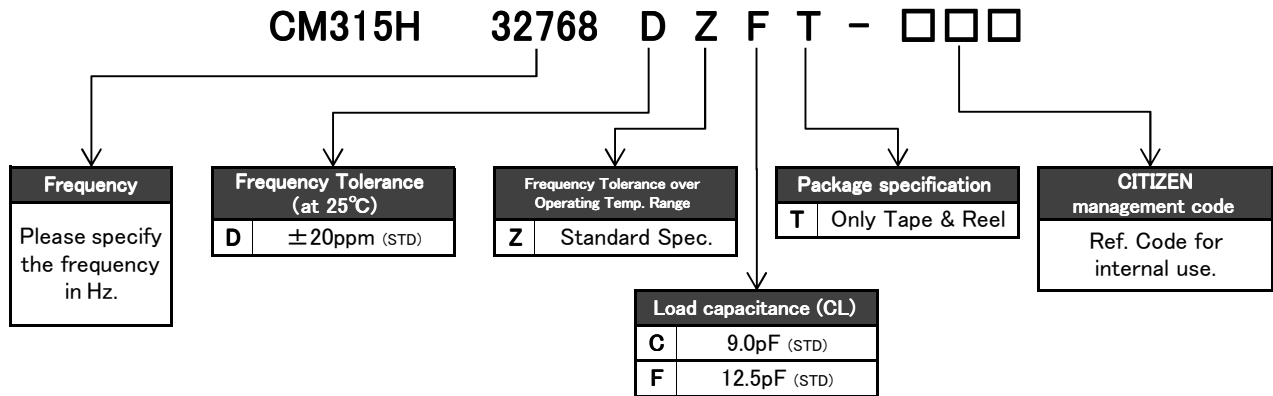

\*Please contact us for specifications available.

## ■ Part Marking [standard]

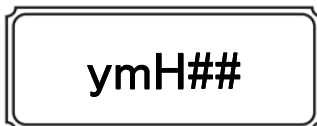

- y : The last digit of production year
- m : Production month (See Table.1)
- H : Manufacture's ID Code
- # : Production Lot No.

Table.1

Month	Jan	Feb	...	Sep	Oct	Nov	Dec
Code	1	2	...	9	X	Y	Z

## ■ Reflow profile

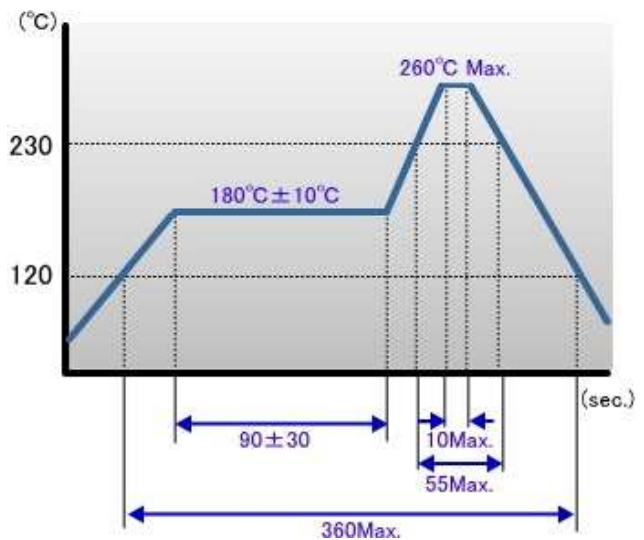

## ■ Packing

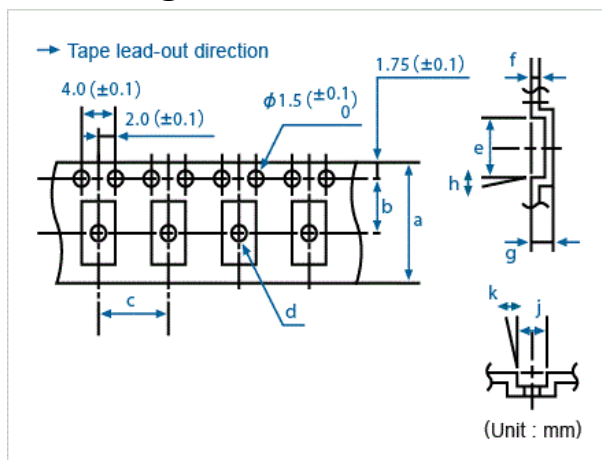

Conforming to JIS C 0806 TB1208NEIAJ and RC-1009B TE1208N

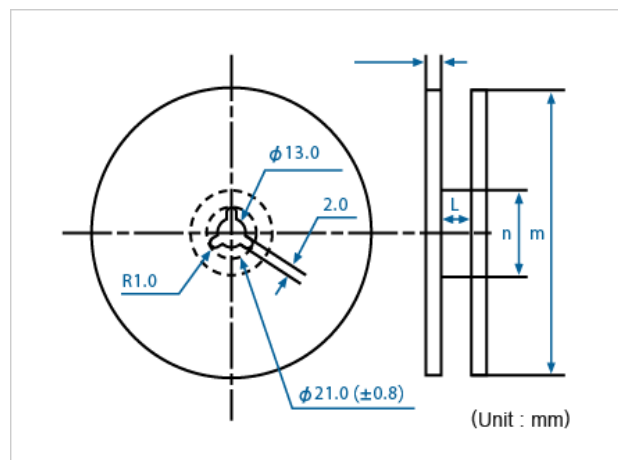

Conforming to JIS C 0806 R12R and EIAJ RC-1009B R15

Q'ty/reel	a	b	c	d (φ)	e	f	g	h	j	k	l	m (φ)	n (φ)
3,000	12.0	5.5	4.0	1.0	3.6	0.3	1.0	5°	1.9	5°	13.0	180	60

Rev.1